

太极芯地弹簧（木门）

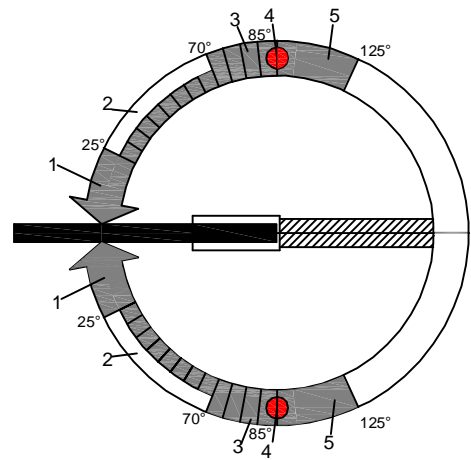

1. 关门范围：25°-0°（以阀门螺丝2调节）
2. 关门范围：70°-25°（以阀门螺丝1调节）
3. 关门范围：85°-70°（不可调节）
4. 定位配置：90°
5. 最大开幅：125°

產品明細

TJ108E

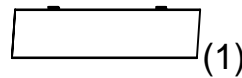
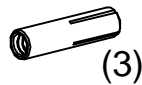
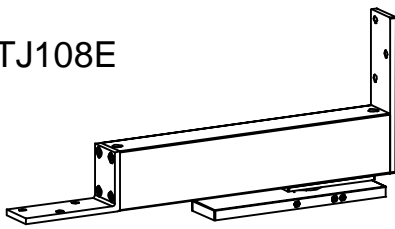

≥36mm

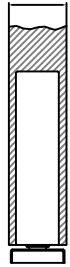

TJ108E.80用

TJA06

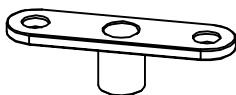

≥40mm

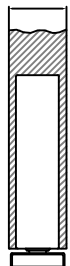

TJ108E.100用

TJA02B

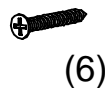
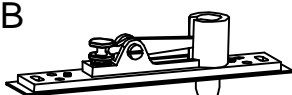

门扇厚度

安装步骤

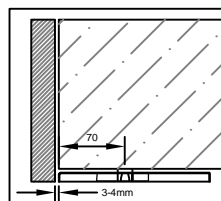
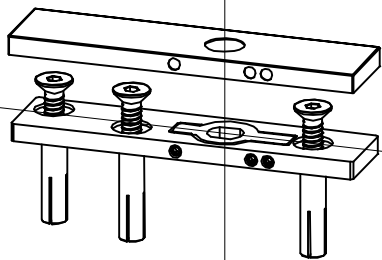

1. 确定地弹簧安装位置，保证水平度与垂直度，根据场景以正确配件安装地弹簧底座，完成后安装面盖。

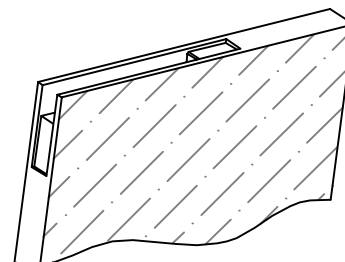
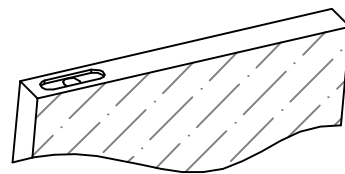

2. 按照纸规于门扇上开孔，以安装地弹簧及上轴。

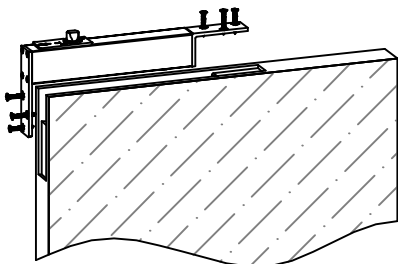
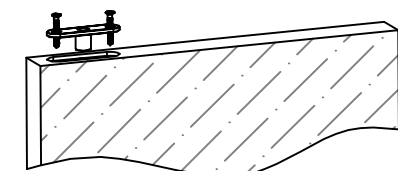

3. 安装地弹簧及上轴于门扇内，并以螺丝固定组件位置。

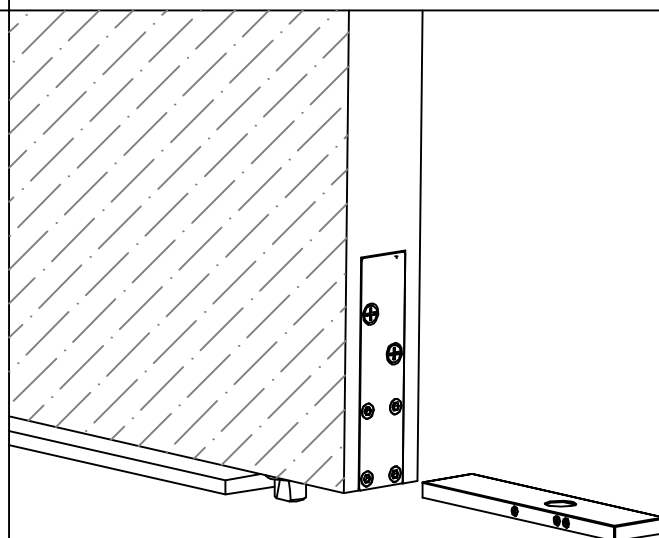

4. 垫高及安装门扇，以保证门扇水平度。此时底座对位螺丝略为松开。

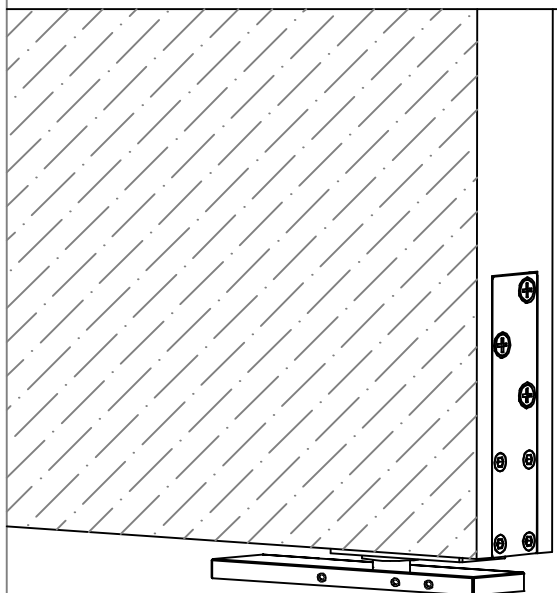

5. 调节底座对位螺丝，以校正垂直度。开关门扇，以确定操作顺畅及无异声。

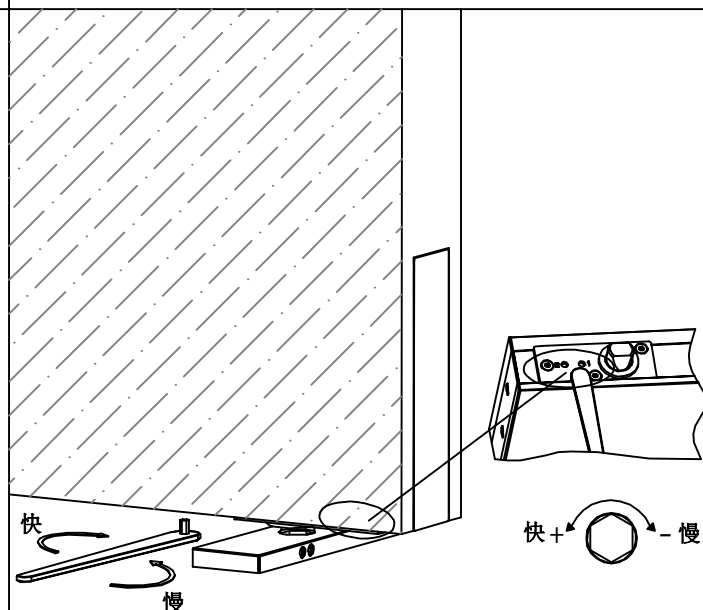

6. 调节地弹簧上的阀门螺丝，以求需要的关门速度及闭锁速度。安装面盖，安装完成。