

靈動 - 多向可調玻璃夾

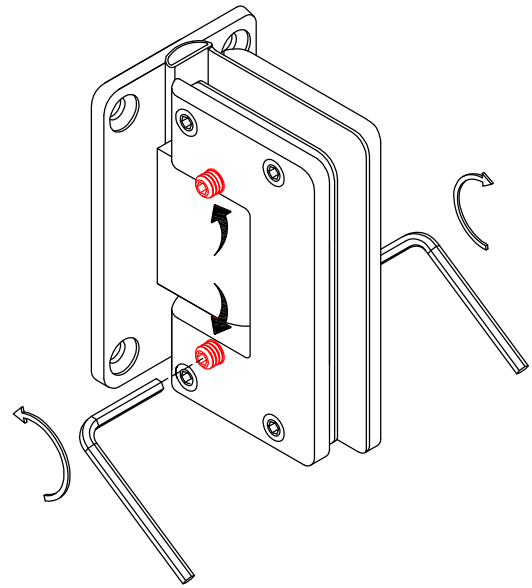

調節前準備

靈動調節系統

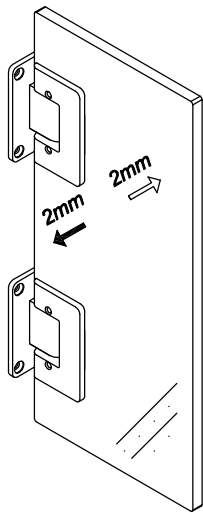

水平度調節

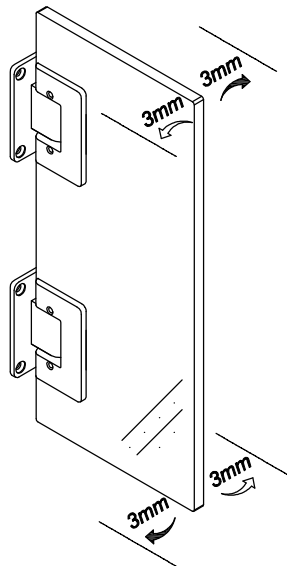

垂直度調節

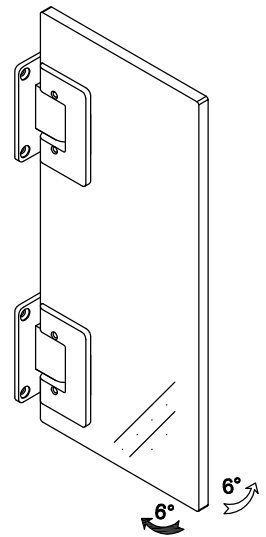

休止角度調節

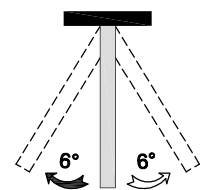
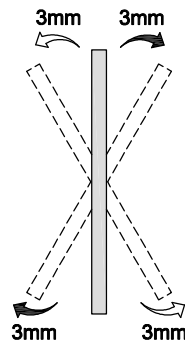
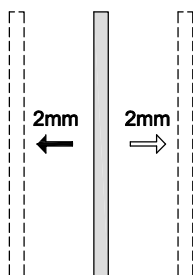

安裝步驟

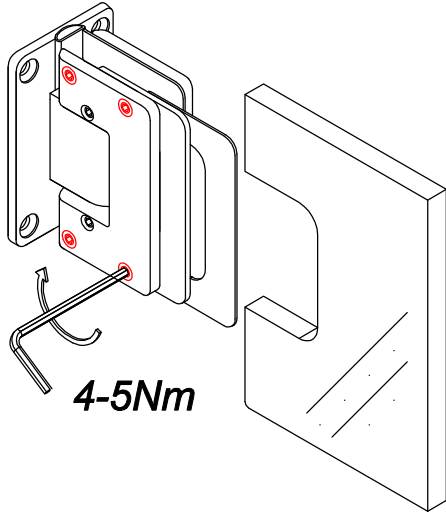

1. 收緊夾板螺絲，將玻璃夾安裝在玻璃門上。

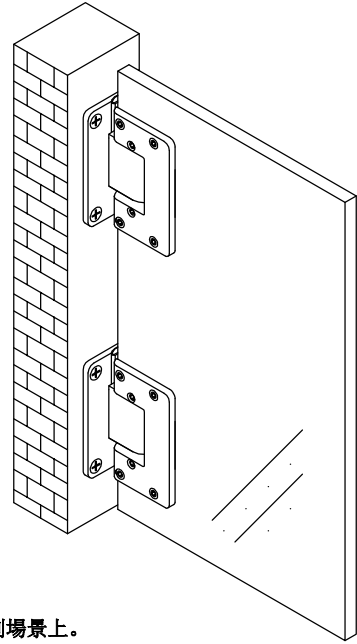

2. 將玻璃門固定到場景上。

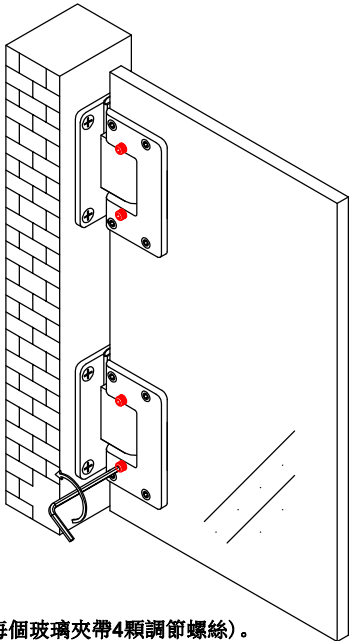

3. 鬆開調節螺絲（每個玻璃夾帶4顆調節螺絲）。

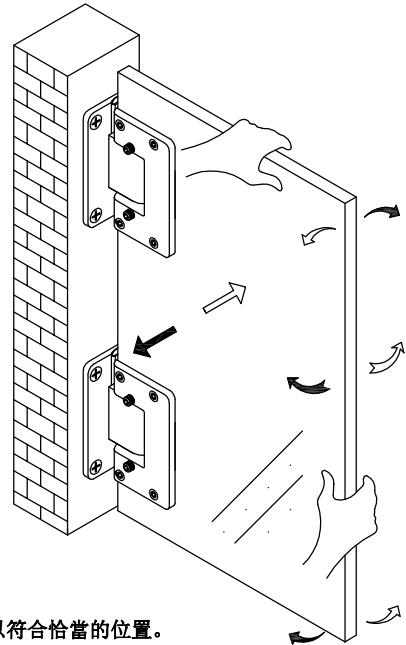

4. 調整玻璃門，以符合恰當的位置。

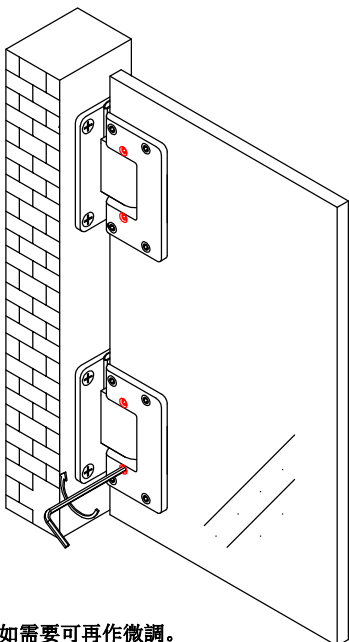

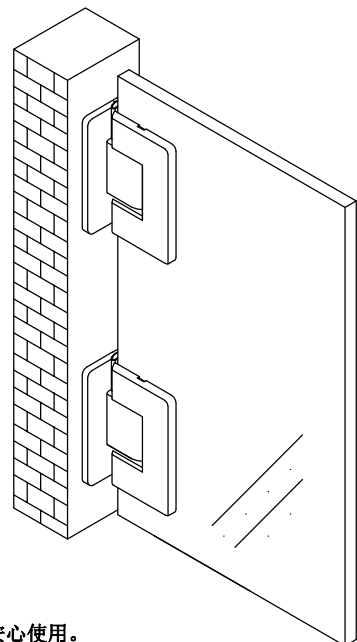

5. 鎖緊調節螺絲，如需要可再作微調。

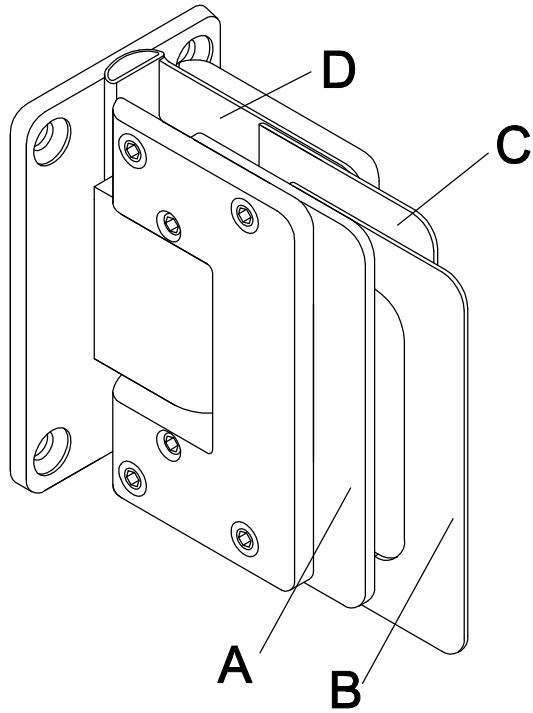

6. 安裝外蓋板及安心使用。

墊片配置

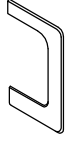

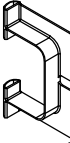
| 墊片 | | 玻璃厚度 | |
|--|----|------|------|
| 款式 | 位置 | 8mm | 10mm |
|  2.5 | A | 1 | 1 |
|  1.0 | B | 1 | 1 |
| | C | 1 | 0 |
|  1.0 | D | 1 | 1 |

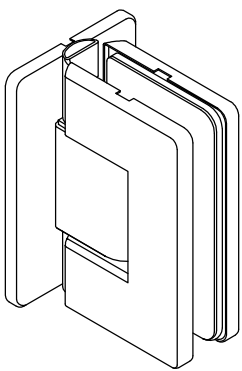

ND012-90°

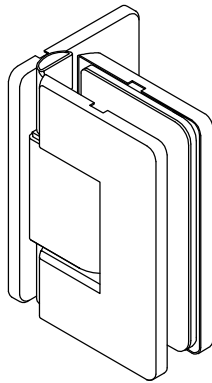

ND012B-90°

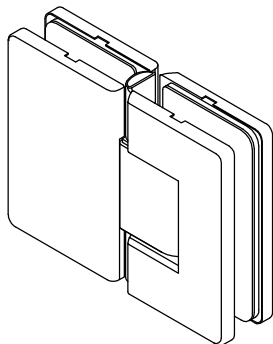
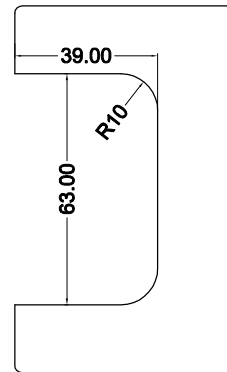

ND021-180°

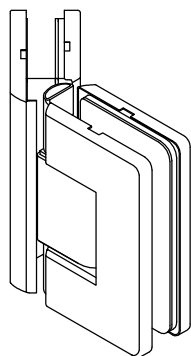

ND009-135°

