

灵动 - 多向可调玻璃夹

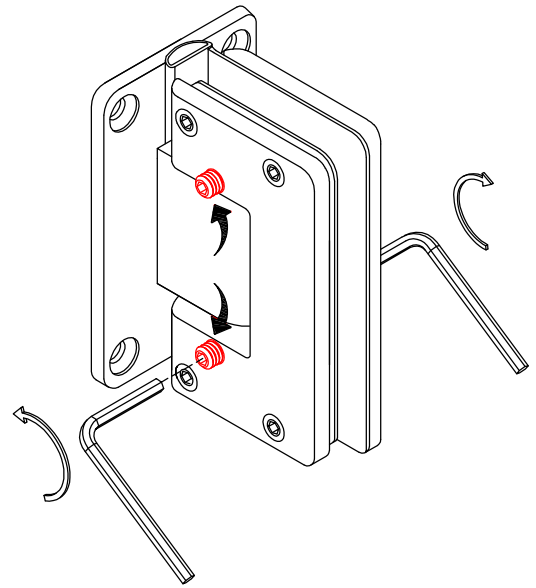

调节前准备

灵动调节系统

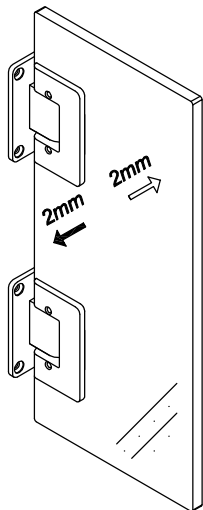

水平度调节

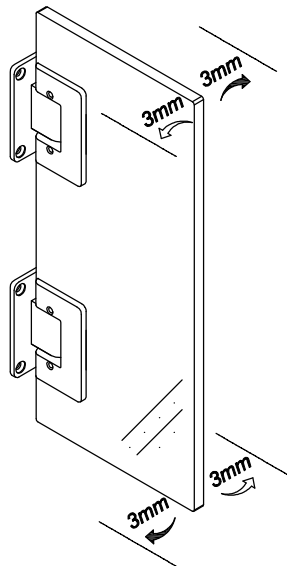

垂直度调节

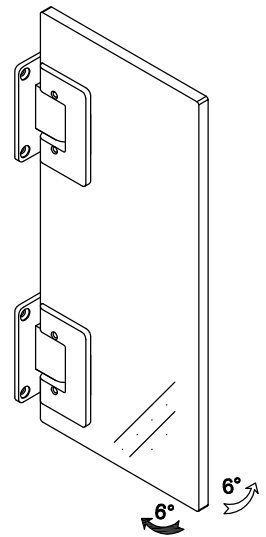

休止角度调节

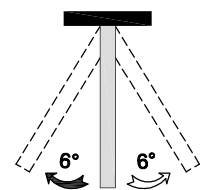
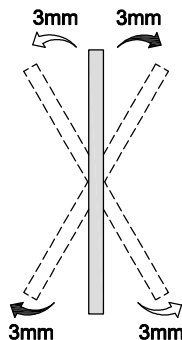
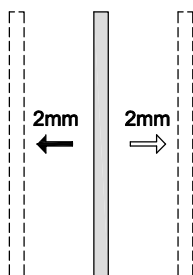

## 安装步骤

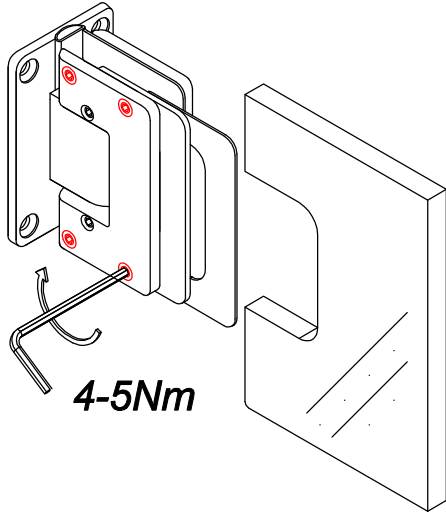

1. 收紧夹板螺丝，将玻璃夹安装在玻璃门上。

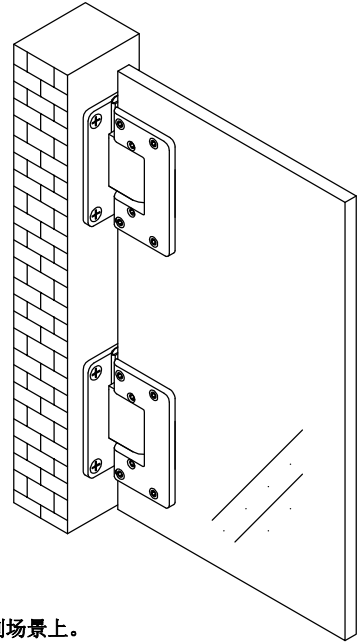

2. 将玻璃门固定到场景上。

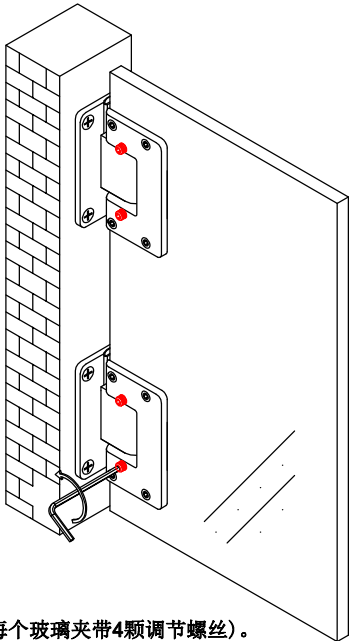

3. 松开调节螺丝(每个玻璃夹带4颗调节螺丝)。

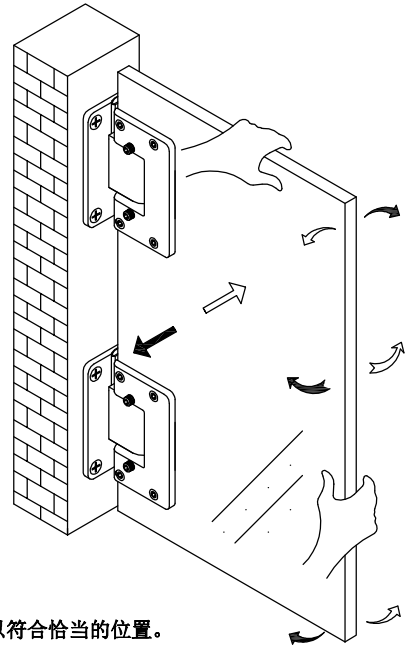

4. 调整玻璃门，以符合恰当的位置。

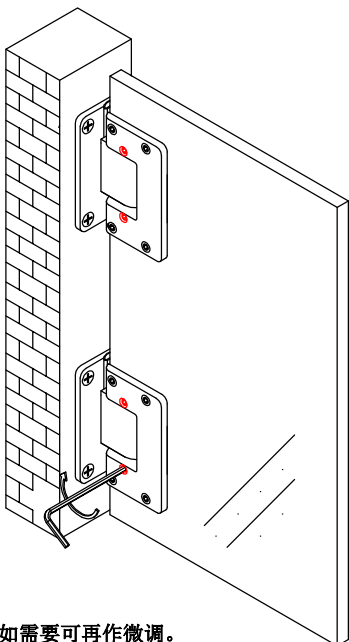

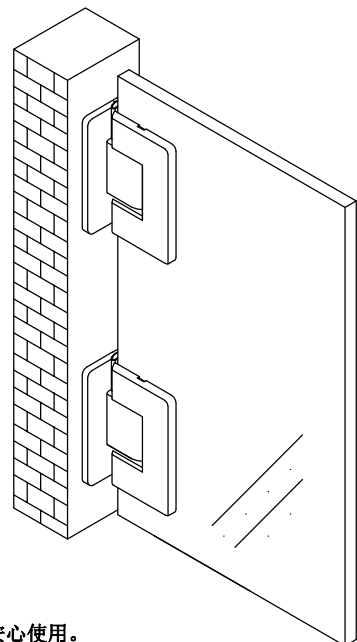

5. 锁紧调节螺丝，如需要可再作微调。

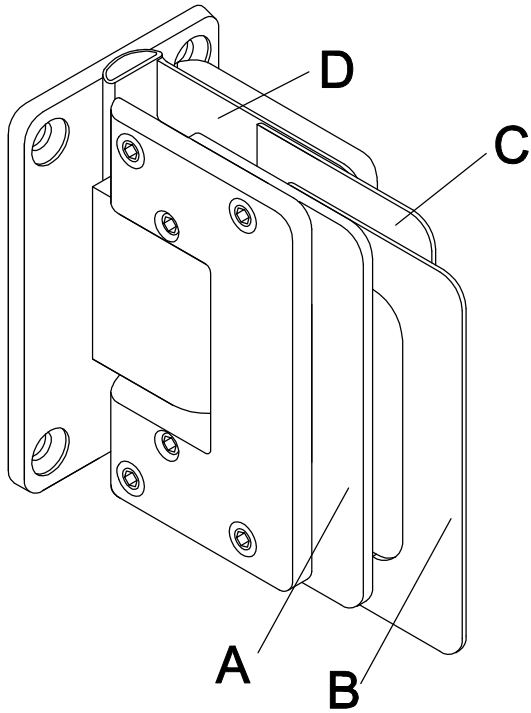

6. 安装外盖板及安心使用。

# 垫片配置

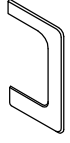

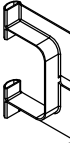
垫片		玻璃厚度	
款式	位置	8mm	10mm
 2.5	A	1	1
 1.0	B	1	1
	C	1	0
 1.0	D	1	1

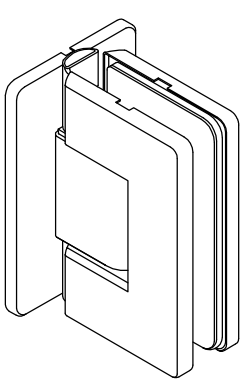

ND012-90°

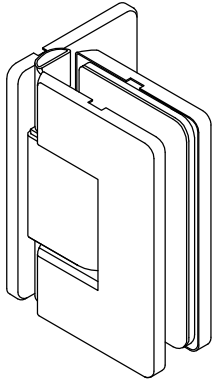

ND012B-90°

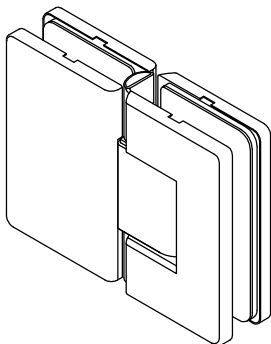
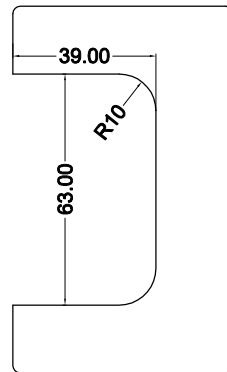

ND021-180°

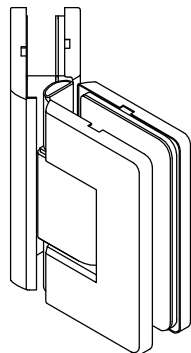

ND009-135°

