

靈動 - 多向可調玻璃夾

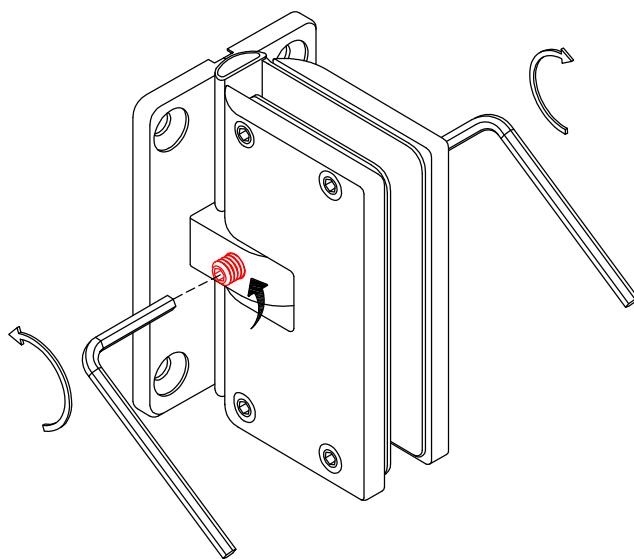

調節前準備

靈動調節系統

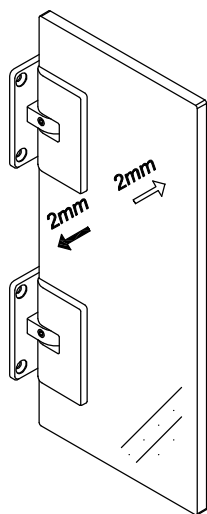

水平度調節

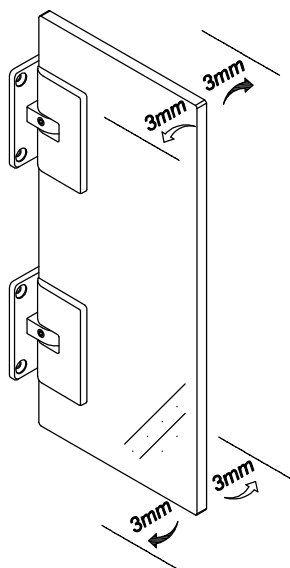

垂直度調節

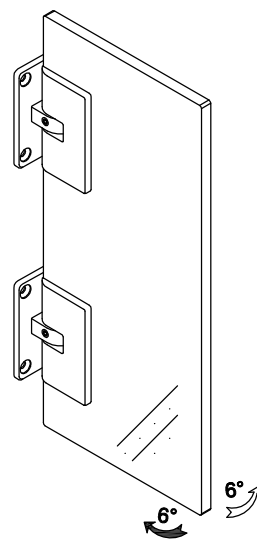

休止角度調節

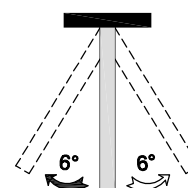
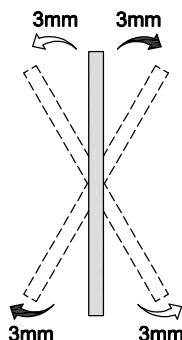
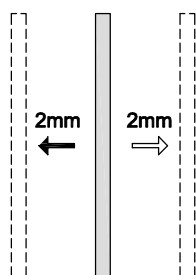

## 安裝步驟

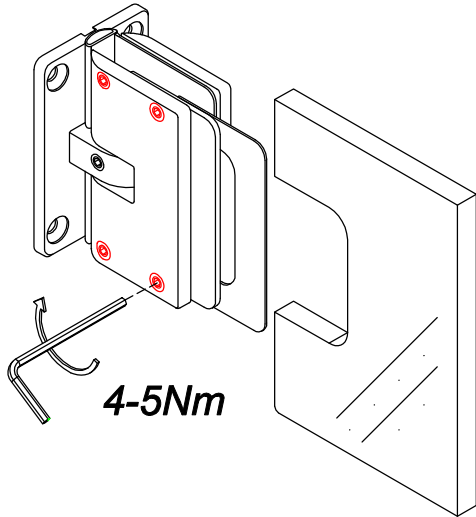

1. 收緊夾板螺絲，將玻璃夾安裝在玻璃門上。

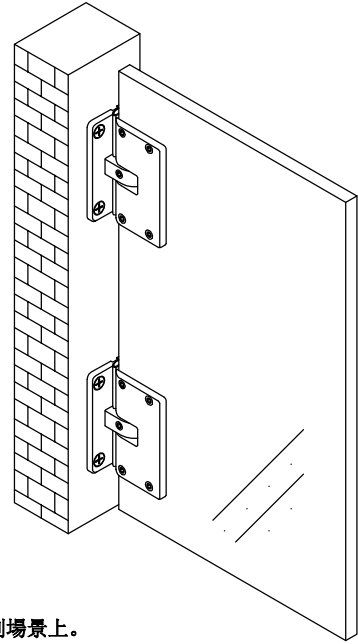

2. 將玻璃門固定到場景上。

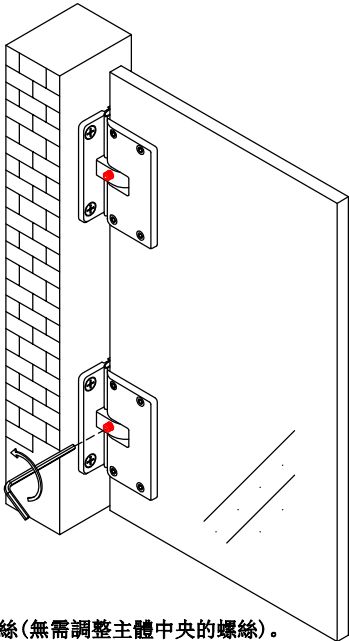

3. 鬆開兩旁調節螺絲(無需調整主體中央的螺絲)。

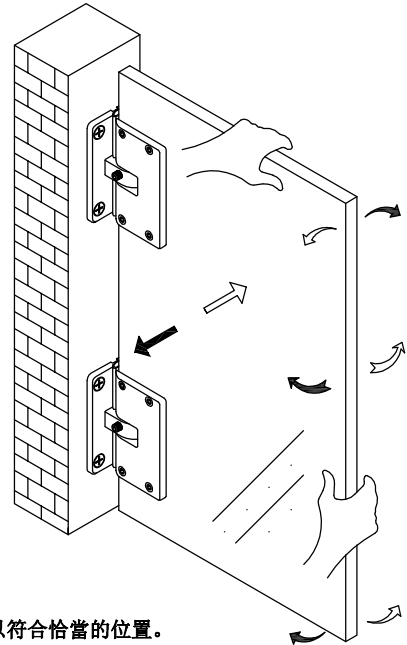

4. 調整玻璃門，以符合恰當的位置。

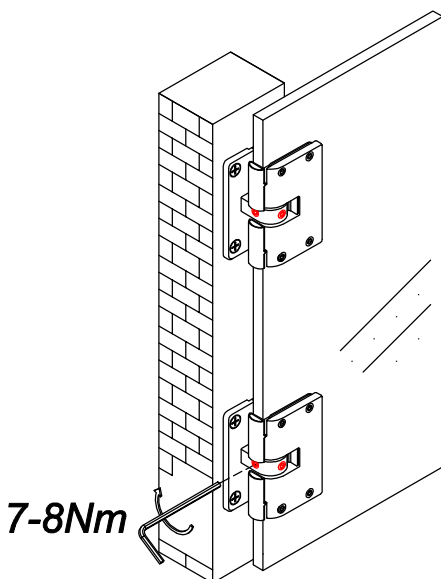

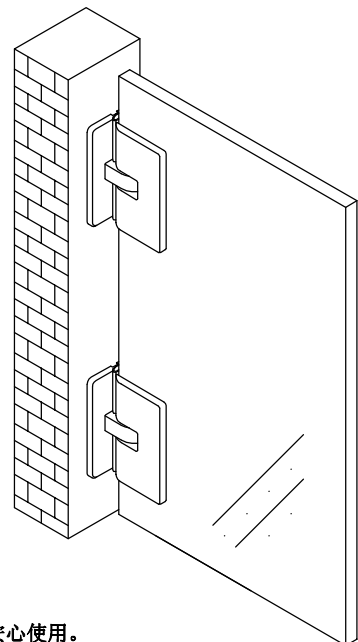

5. 鎖緊調節螺絲(每個玻璃夾帶3顆調節螺絲)，如需要可再作微調。

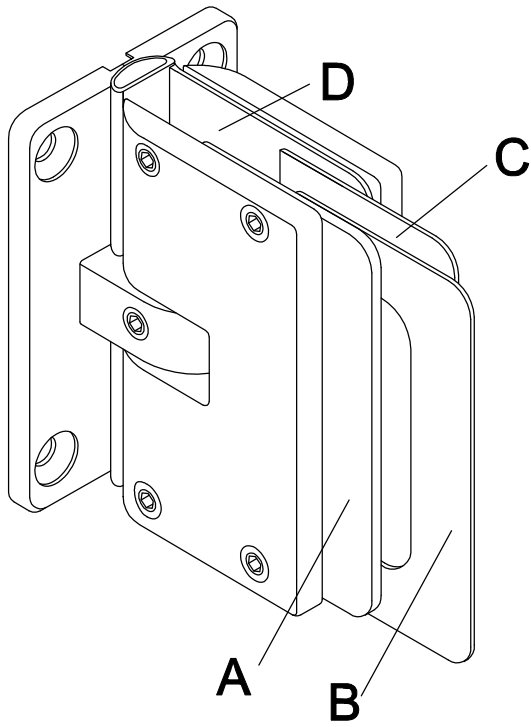

6. 安裝外蓋板及安心使用。

# 墊片配置

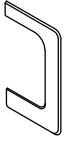

墊片		玻璃厚度	
款式	位置	8mm	10mm
 2.5	A	1	1
 1.0	B	1	1
	C	1	0
 1.0	D	1	1

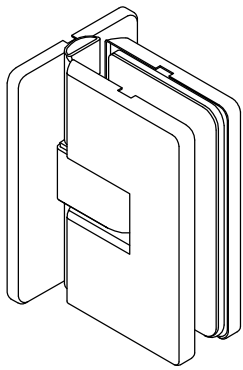

ND601

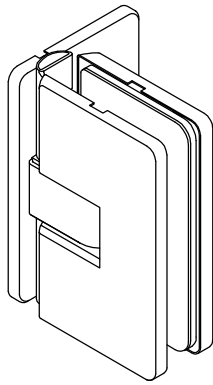

ND602

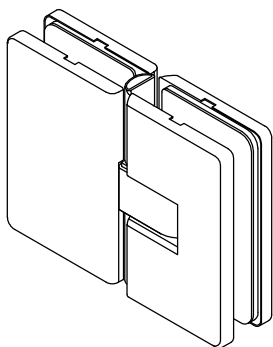
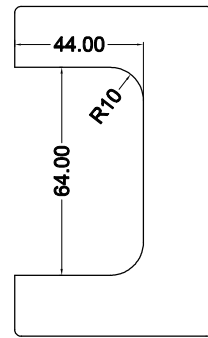

ND603

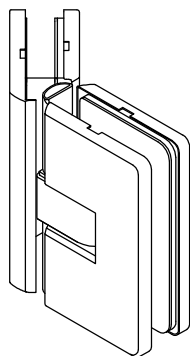

ND604

